

ANGEL 3 1000 CHANDELIER

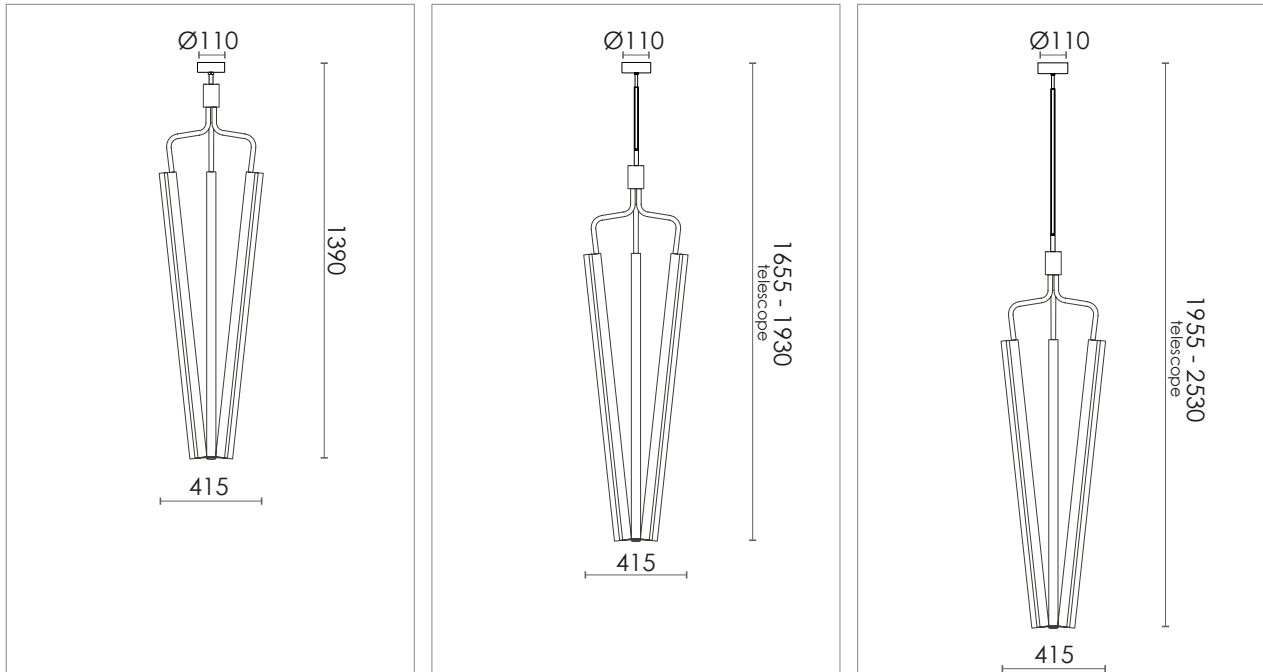

DESIGN SPECIFICATIONS

DIMENSIONS (mm)	W 415 x H 1390 W 415 x H 1655-1930 W 415 x H 1955-2530
WEIGHT (kg)	- / - / -
MATERIALS	THE LAMP IS MADE FROM CLEAR LACQURED BRASS, STEEL OR POWDER COATED STEEL.
CORD (mm)	NO
ENVIRONMENT	INDOOR
DESIGN BY	NICLAS HOFLIN
DESIGN YEAR	2019

ELECTRICAL SPECIFICATIONS

SWITCH	NO
BULB HOLDER	S14S
LIGHT SOURCE	INCLUDED 3 X 15 W DIMMABLE LED - 2700 K
DIMMABLE	YES
MAX (W)	45 W LED
VOLTAGE	230 / 240
CLASS	1
IP	20

COLOURS

	BLACK	H 1390 ART.NO. 913201005	H 1655-1930 ART.NO. 913202005	H 1955-2530 ART.NO. 913203005
	BRASS	H 1390 ART.NO. 913201001	H 1655-1930 ART.NO. 913202001	H 1955-2530 ART.NO. 913203001
	BRONZE-COLOR	H 1390 ART.NO. 913201223	H 1655-1930 ART.NO. 913202223	H 1955-2530 ART.NO. 913203223
	STEEL	H 1390 ART.NO. 913201500	H 1655-1930 ART.NO. 913202500	H 1955-2530 ART.NO. 913203500